

MOVE IT 1.1

DIRECT/INDIRECT

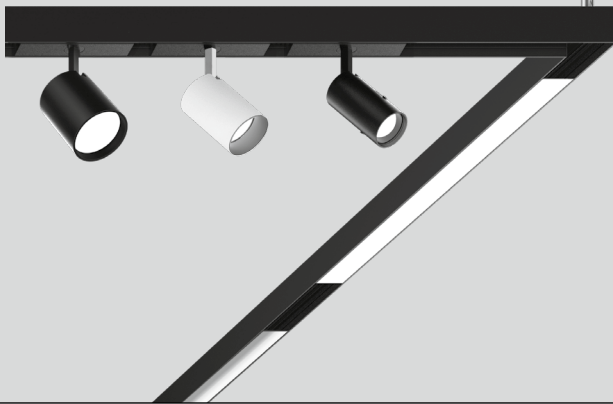

PERFORMANCE

- 48V low voltage track
- Multiple inset options
- CRI > 90
- Flexible magnetic profile system

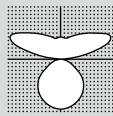

MOUNTING

Pendant

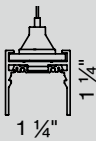

PATTERNS



X Shapes



Custom Angles



L Shapes



Rectangles



T Shapes

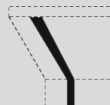

Wall to Ceiling

For more patterns, please contact customer service

MAGNETIC ATTACHMENT



[link to video](#)

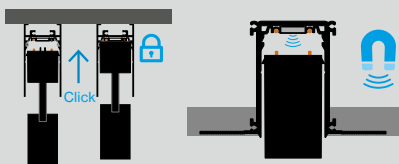

Physical attributes

A RANGE

MOVE IT 1.1 MOVE 1 . 1

B MOUNTING

CS Pendant P D T

pendant suspension set includes cable suspension and one white J-box cover

C COLOR outside / inside

White / Black W H

CS Black / Black B L

D INDIRECT LENS

Batwing uplight B W

E CCT

2700K 2 7 K

3000K 3 0 K

3500K 3 5 K

F CRI

CRI > 90 C 9 0

Electrical attributes

G VOLTAGE

48V 4 8 V

constant voltage track

H DIMMING

CS 0-10V 1% single control 0 1 0 V

0-10V 1% dual control* D C 1 0

*two 0-10V dimming outputs

Lutron 5% single control L E S 1

wiring diagram is on power supply page

I OUTPUT LM/FT INDIRECT

500lm/ft ± 0 5 0 0 L F

Dimensional attributes

J SHAPE / PATTERN

CS Linear S T

L-shape L S

□-shape (rectangular shape) R S

U-shape U S

Z-shape Z S

Wall to ceiling W C

Custom shape X X

for more patterns, please consult customer service (RCP required)

Accessories

BLIND COVER
(field cuttable)



LENGTH
FT / INCH **COLOR**

4' black N 5 0 - 4 0 0 4 0 0 8

8' black N 5 0 - 4 0 0 8 0 0 8



1/8"

K DIMENSIONS IN FEET

Linear 2' 0 2 FT

CS Linear 4' 0 4 FT

Linear 6' 0 6 FT

CS Linear 8' 0 8 FT

Linear custom # # FT

L-shape # # X # # FT

custom

□-shape # # X # # FT

custom

U-shape # # X # # X # # FT

custom

Z-shape # # X # # X # # FT

custom

dimensions starting at 2' in 1'

increments; for custom dimensions,

please consult customer service; track

not field-cuttable

Channel

UPLIGHT direct / batwing uplight / 4W/ft / 27K / 30K / 35K

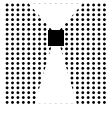

PROFILE LENGTH	UPLIGHT LENGTH	INPUT WATTS	DELIVERED LUMENS
2'	1 1/2'	8W	1000 lm
4'	3 1/2'	16W	1500 lm

Possible shapes top view please provide RCP to ensure correct shape orientation

LINEAR

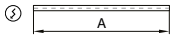

L-SHAPE

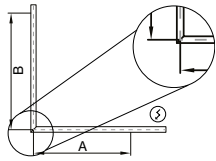

Z-SHAPE

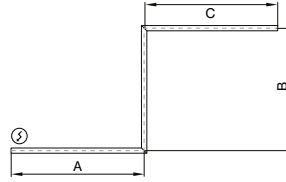

□-SHAPE

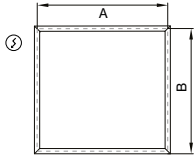

U-SHAPE

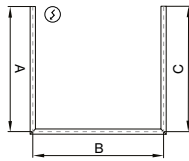

WALL TO CEILING

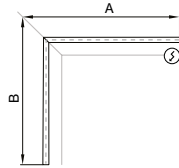

for more patterns, please contact customer service (RCP required)



low voltage power feeder

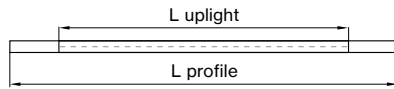

Power feeder locations

POWER FEED

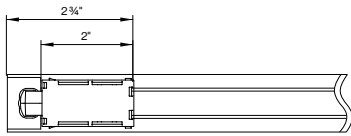

LINEAR POWER COUPLER

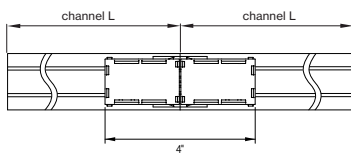

CORNER POWER COUPLER

SINGLE CONTROL (010V)

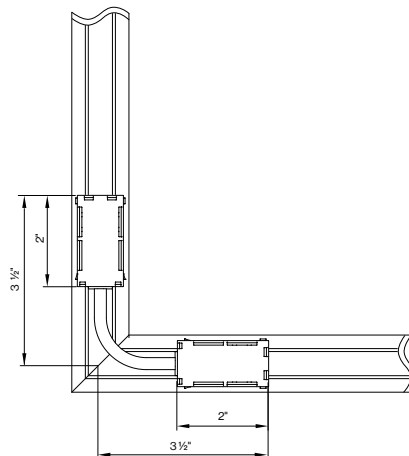

DUAL CONTROL (DC10)

