

MOVE IT 1.2

DIRECT

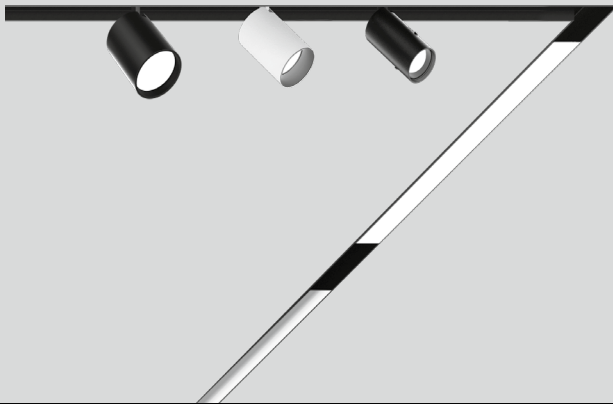

5 YEAR
limited
led warranty



Physical attributes

A RANGE

MOVE IT 1.2 MOVE 1 . 2

B MOUNTING

Recessed trimless R T L

C COLOR

Black B L

Dimensional attributes

F SHAPE / PATTERN

CS Linear	S T
L-shape	L S
□-shape (rectangular shape)	R S
U-shape	U S
Z-shape	Z S
Wall to ceiling	WC
Custom shape	X X

for more patterns, please consult customer service (RCP required)

G DIMENSIONS IN FEET

Linear 2'	0 2 FT
CS Linear 4'	0 4 FT
Linear 6'	0 6 FT
CS Linear 8'	0 8 FT
linear custom	# # FT
L-shape	# # X # # FT
custom	
□-shape	# # X # # FT
custom	
U-shape	# # X # # X # # FT
custom	
Z-shape	# # X # # X # # FT
custom	

dimensions starting at 2' in 1' increments; for custom dimensions, please consult customer service; track not field-cuttable

Electrical attributes

D VOLTAGE

48 V 4 8 V
constant voltage track

E DIMMING

CS 0-10V 1% single control	0 1 0 V
0-10V 1% dual control*	DC 1 0
*two 0-10V dimming outputs	
Lutron 5% single control	L E S 1

wiring diagram is on power supply page

PERFORMANCE

- 48V low voltage track
- Multiple inset options
- CRI > 90+
- Flexible magnetic profile system

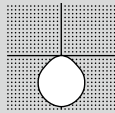

MOUNTING

Recessed

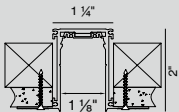

PATTERNS



X Shapes



Custom Angles



L Shapes



Rectangles



T Shapes

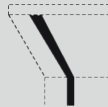

Wall to Ceiling

For more patterns, please contact customer service

Accessories

BLIND COVER
(field cuttable)



1 1/8"

LENGTH
FT / INCH COLOR

4'	black	N 5 0 - 4 0 0 4 0 0 8
8'	black	N 5 0 - 4 0 0 8 0 0 8

MAGNETIC ATTACHMENT



[link to video](#)

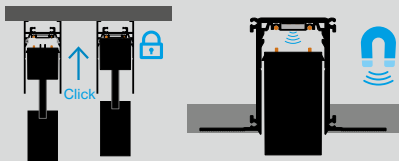

MOVE IT 1.2 channel dimensions

RECESSED

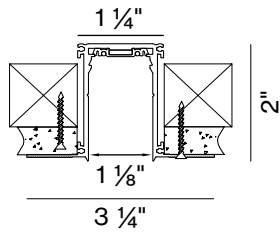

Possible shapes top view

please provide RCP to ensure correct shape orientation

LINEAR

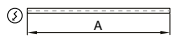

L-SHAPE

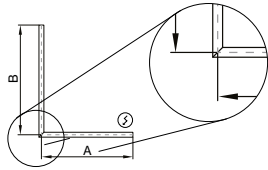

Z-SHAPE

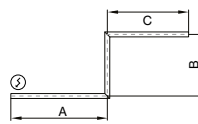

□-SHAPE

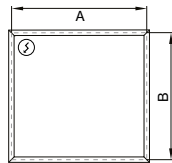

U-SHAPE

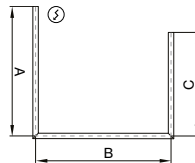

WALL TO CEILING

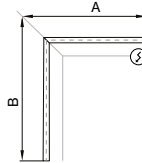

Power feeder locations

POWER FEED

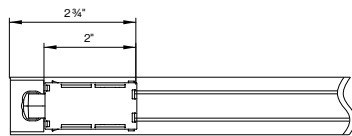

LINEAR POWER COUPLER

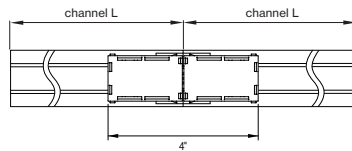

CORNER POWER COUPLER

SINGLE CONTROL (010V)

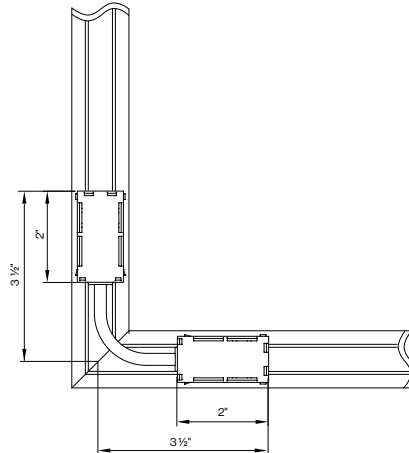

DUAL CONTROL (DC10)

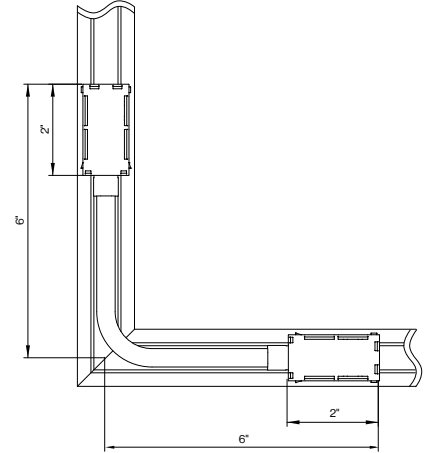

MOVE IT 1.2 mounting instructions

Get access to the MOVE IT 1.2 mounting instructions faster by scanning the QR code.



<https://www.xalusa.com/resources/mounting-instructions/move-it-system>